

The latest versatile LMS-6i profile is ideal for many applications. It creates a continuous light effect through internal and external corners and angles, in recessed installations. It comes with a range of pre-made linear extensions and modular connectors ('T', 'L' and 'X' shapes and 135° version) making this ideal for perfecting the seamless effect.

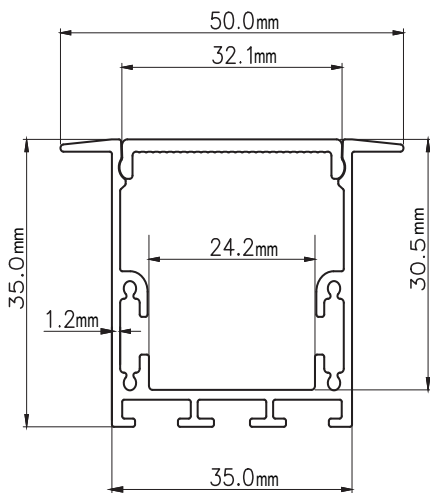

## MODULAR ALUMINIUM PROFILES SPECIFICATION

Code	Description	Dimensions
LMS-6i/1M	Modular aluminium profile recessed SET	1m
LMS-6i/2M	Modular aluminium profile recessed SET	2m
LMS-6i/L90	90° Corner connector SET	20 X 20cm
LMS-6i/L90INT	90° Internal corner connector SET	20 X 20cm
LMS-6i/L90EXT	90° External corner connector SET	20 X 20cm
LMS-6i/X90	X shaped connector SET	40 X 40cm
LMS-6i/T90	T shaped connector SET	40 X 20cm
LMS-6i/L135	135° Angle connector SET	20 X 20cm
Construction	anodised aluminium 6063 * black * white	
IP rating	IP20	

\* available upon request, subject to MOQ. All sets include diffusers.

## ACCESSORIES

Code	Item
LM-RAIL	Rail connector for LMS-5, LMS-5i, LMS-6i, LMP-6 & LMP-6e
LMS-6i/ENDCAPS	2 pcs of end caps for LMS-6i
LMS-6i/Bracket	(x2) Mounting bracket for LMS-6i

Please note that with the continuous rapid development in lighting technology, specification values may change. Contact our technical department for details. We reserve the right to amend or change details without prior notification. All performance data is taken at an ambient temperature of +25°C. Lumens and connected system load are subject to an initial tolerance of up to +/- 10%.

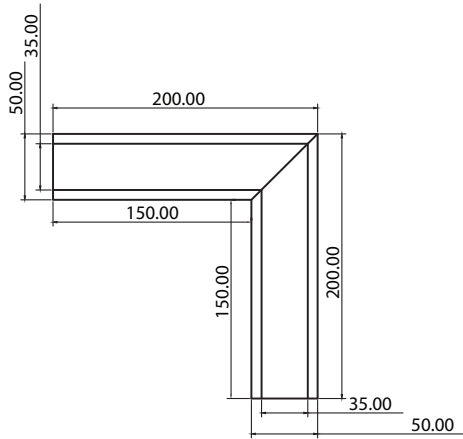

LMS-6i/L90

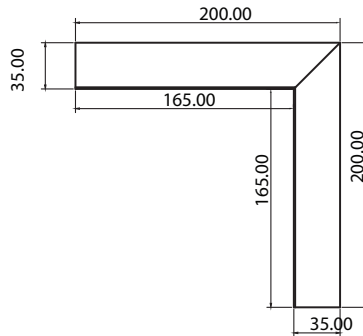

LMS-6i/L90INT

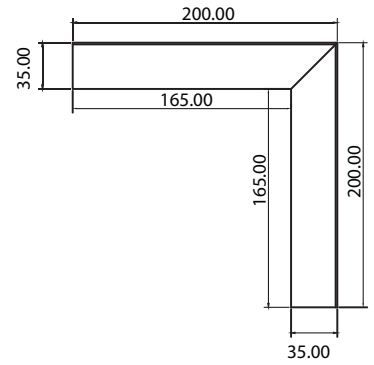

LMS-6i/L90EXT

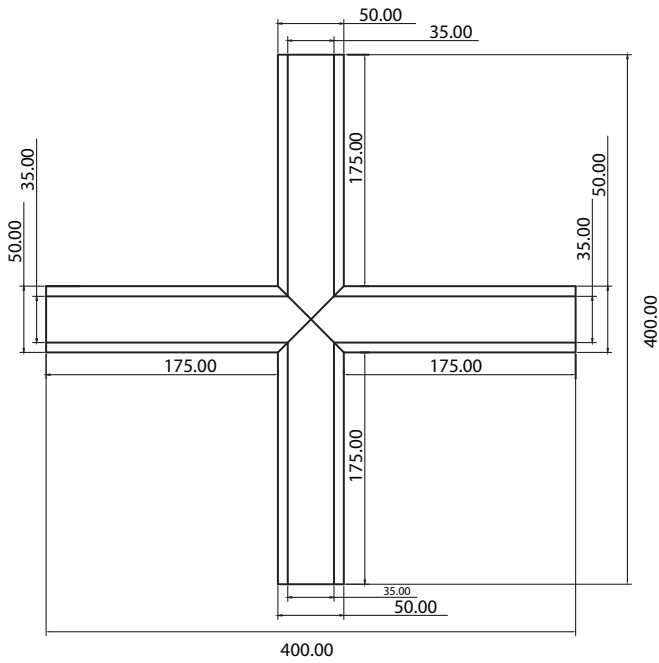

LMS-6i/X90

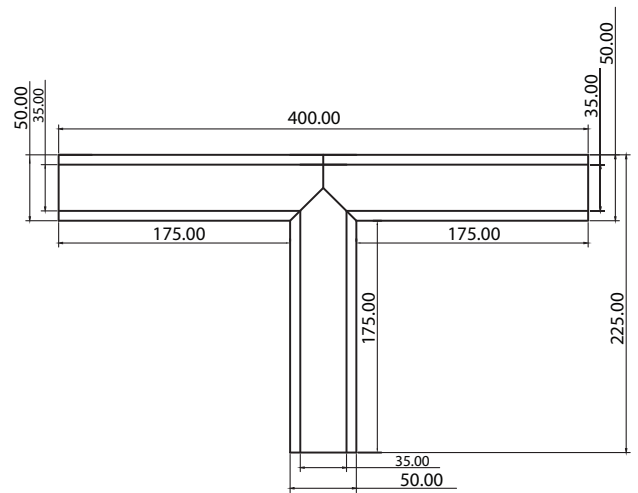

LMS-6i/T90

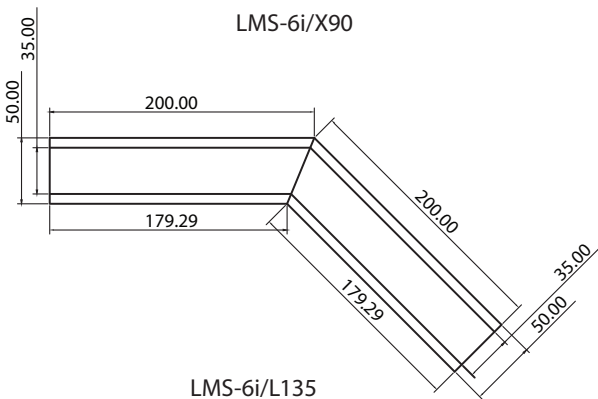

LMS-6i/L135

\* dimensions are in mm

